



ONKYO®

CD Receiver

CR-505DAB

Instruction Manual



Thank you for purchasing an Onkyo CD Receiver. Please read this manual thoroughly before making connections and turning on the power. Following the instructions in this manual will enable you to obtain optimum performance and listening enjoyment from your new CD Receiver. Please retain this manual for future reference.

Contents

Introduction	2
Connections	11
Getting Started	16
CD/MP3 Playback	20
DAB	24
FM/AM	28
Using Other Functions	31
Appendix	35



WARNING:

TO REDUCE THE RISK OF FIRE OR ELECTRIC SHOCK, DO NOT EXPOSE THIS APPARATUS TO RAIN OR MOISTURE.

CAUTION:

TO REDUCE THE RISK OF ELECTRIC SHOCK, DO NOT REMOVE COVER (OR BACK). NO USER-SERVICEABLE PARTS INSIDE. REFER SERVICING TO QUALIFIED SERVICE PERSONNEL.



WARNING
RISK OF ELECTRIC SHOCK
DO NOT OPEN

AVIS
RISQUE DE CHOC ELECTRIQUE
NE PAS OUVRIR



The lightning flash with arrowhead symbol, within an equilateral triangle, is intended to alert the user to the presence of uninsulated "dangerous voltage" within the product's enclosure that may be of sufficient magnitude to constitute a risk of electric shock to persons.



The exclamation point within an equilateral triangle is intended to alert the user to the presence of important operating and maintenance (servicing) instructions in the literature accompanying the appliance.

Important Safety Instructions

1. Read these instructions.
2. Keep these instructions.
3. Heed all warnings.
4. Follow all instructions.
5. Do not use this apparatus near water.
6. Clean only with dry cloth.
7. Do not block any ventilation openings. Install in accordance with the manufacturer's instructions.
8. Do not install near any heat sources such as radiators, heat registers, stoves, or other apparatus (including amplifiers) that produce heat.
9. Do not defeat the safety purpose of the polarized or grounding-type plug. A polarized plug has two blades with one wider than the other. A grounding type plug has two blades and a third grounding prong. The wide blade or the third prong are provided for your safety. If the provided plug does not fit into your outlet, consult an electrician for replacement of the obsolete outlet.
10. Protect the power cord from being walked on or pinched particularly at plugs, convenience receptacles, and the point where they exit from the apparatus.
11. Only use attachments/accessories specified by the manufacturer.
12. Use only with the cart, stand, tripod, bracket, or table specified by the manufacturer, or sold with the apparatus. When a cart is used, use caution when moving the cart/apparatus combination to avoid injury from tip-over.

PORTABLE CART WARNING

S3125A
13. Unplug this apparatus during lightning storms or when unused for long periods of time.
14. Refer all servicing to qualified service personnel. Servicing is required when the apparatus has been damaged in any way, such as power-supply cord or plug is damaged, liquid has been spilled or objects have fallen into the apparatus, the apparatus has been exposed to rain or moisture, does not operate normally, or has been dropped.
15. Damage Requiring Service

Unplug the apparatus from the wall outlet and refer servicing to qualified service personnel under the following conditions:

 - A. When the power-supply cord or plug is damaged,
 - B. If liquid has been spilled, or objects have fallen into the apparatus,
 - C. If the apparatus has been exposed to rain or water,
 - D. If the apparatus does not operate normally by following the operating instructions. Adjust only those controls that are covered by the operating instructions as an improper adjustment of other controls may result in damage and will often require extensive work by a qualified technician to restore the apparatus to its normal operation,
 - E. If the apparatus has been dropped or damaged in any way, and
 - F. When the apparatus exhibits a distinct change in performance this indicates a need for service.
16. Object and Liquid Entry

Never push objects of any kind into the apparatus through openings as they may touch dangerous voltage points or short-out parts that could result in a fire or electric shock.

The apparatus shall not be exposed to dripping or splashing and no objects filled with liquids, such as vases shall be placed on the apparatus.

Don't put candles or other burning objects on top of this unit.
17. Batteries

Always consider the environmental issues and follow local regulations when disposing of batteries.
18. If you install the apparatus in a built-in installation, such as a bookcase or rack, ensure that there is adequate ventilation.

Leave 20 cm (8") of free space at the top and sides and 10 cm (4") at the rear. The rear edge of the shelf or board above the apparatus shall be set 10 cm (4") away from the rear panel or wall, creating a flue-like gap for warm air to escape.

Precautions

1. Recording Copyright

Unless it's for personal use only, recording copyrighted material is illegal without the permission of the copyright holder.

2. AC Fuse

The AC fuse inside the CR-505DAB is not user-serviceable. If you cannot turn on the CR-505DAB, contact your Onkyo dealer.

3. Care

Occasionally you should dust the CR-505DAB all over with a soft cloth. For stubborn stains, use a soft cloth dampened with a weak solution of mild detergent and water. Dry the CR-505DAB immediately afterwards with a clean cloth. Don't use abrasive cloths, thinners, alcohol, or other chemical solvents, because they may damage the finish or remove the panel lettering.

4. Power

WARNING

BEFORE PLUGGING IN THE UNIT FOR THE FIRST TIME, READ THE FOLLOWING SECTION CAREFULLY.

AC outlet voltages vary from country to country. Make sure that the voltage in your area meets the voltage requirements printed on the CR-505DAB's rear panel (AC 230 -240 V, 50 Hz).

Setting the [STANDBY/ON] switch to STANDBY does not fully shutdown the CR-505DAB. If you do not intend to use the CR-505DAB for an extended period, remove the power cord from the AC outlet.

5. Never Touch This Unit with Wet Hands

Never handle this unit or its power cord while your hands are wet or damp. If water or any other liquid gets inside this unit, have it checked by your Onkyo dealer.

6. Installing This Unit

- Install this unit in a well-ventilated location.
- Ensure that there's adequate ventilation all around this unit, especially if it's installed in an audio rack. If the ventilation is inadequate, the unit may overheat, leading to malfunction.
- Do not expose this unit to direct sunlight or heat sources, because its internal temperature may rise, shortening the life of the optical pickup.
- Avoid damp and dusty places, and places subject to vibrations from loudspeakers. Never put the unit on top of, or directly above, a loudspeaker.
- Install this unit horizontally. Never use it on its side or on a sloping surface, because it may cause a malfunction.
- If you install this unit near a TV, radio, or VCR, the sound quality may be affected. If this occurs, move this unit away from the TV, radio, or VCR.

7. Moisture Condensation

Moisture condensation may damage this unit.

Read the following carefully:

When you take a glass containing a cold drink outside on a summer's day, drops of water, called condensation, form on the outside of the glass. Similarly, moisture may condense on the lens of the optical pickup, one of the most important parts inside this unit.

- Moisture condensation can occur in the following situations:
 - The unit is moved from a cold place to a warm place.
 - A heater is turned on, or cold air from an air conditioner is hitting the unit.
 - In the summer, when this unit is moved from an air conditioned room to a hot and humid place.
 - The unit is used in a humid place.
- Do not use this unit when there's the possibility of moisture condensation occurring. Doing so may damage your discs and certain parts inside this unit.

If condensation does occur, remove all discs and leave this unit turned on for two to three hours. By this time, the unit will have warmed up and any condensation will have evaporated. To reduce the risk of condensation, keep this unit connected to a wall outlet.

For British models

Replacement and mounting of an AC plug on the power supply cord of this unit should be performed only by qualified service personnel.

IMPORTANT

The wires in the mains lead are coloured in accordance with the following code:

Blue: Neutral

Brown: Live

As the colours of the wires in the mains lead of this apparatus may not correspond with the coloured markings identifying the terminals in your plug, proceed as follows:

The wire that is coloured blue must be connected to the terminal that is marked with the letter N or coloured black.

The wire that is coloured brown must be connected to the terminal that is marked with the letter L or coloured red.

IMPORTANT

A 3, 5 or 13 ampere fuse is fitted in this plug. Should the fuse need to be replaced, please ensure that the replacement fuse has a rating of 3, 5 or 13 amperes and that it is approved by ASTA or BSI to BS1362. Check for the ASTA mark or the BSI mark on the body of the fuse.

IF THE FITTED MOULDED PLUG IS UNSUITABLE FOR THE SOCKET OUTLET IN YOUR HOME THEN THE FUSE SHOULD BE REMOVED AND THE PLUG CUT OFF AND DISPOSED OF SAFELY. THERE IS A DANGER OF SEVERE ELECTRICAL SHOCK IF THE CUT OFF PLUG IS INSERTED INTO ANY 13 AMPERE SOCKET.

If in any doubt, consult a qualified electrician.

Precautions—Continued

This unit contains a semiconductor laser system and is classified as a "CLASS 1 LASER PRODUCT." So, to use this model properly, read this Instruction Manual carefully. In case of any trouble, please contact the store where you purchased the unit. To prevent exposure to the laser beam, do not try to open the enclosure.

DANGER:

VISIBLE AND INVISIBLE LASER RADIATION WHEN OPEN AND INTERLOCK FAILED OR DEFEATED. DO NOT STARE INTO BEAM.

CAUTION:

THIS PRODUCT UTILIZES A LASER. USE OF CONTROLS OR ADJUSTMENTS OR PERFORMANCE OF PROCEDURES OTHER THAN THOSE SPECIFIED HEREIN MAY RESULT IN HAZARDOUS RADIATION EXPOSURE.



This label is located on the side of the unit. It indicates that:

1. This unit is a CLASS 1 LASER PRODUCT and employs a laser inside the cabinet.
2. To prevent the laser from being exposed, do not remove the cover. Refer servicing to qualified personnel.

Declaration of Conformity

We, ONKYO EUROPE
ELECTRONICS GmbH
LIEGNITZERSTRASSE 6,
82194 GROEBENZELL,
GERMANY



declare in own responsibility, that the ONKYO product described in this instruction manual is in compliance with the corresponding technical standards such as EN60065, EN55013, EN55020 and EN61000-3-2, -3-3.

GROEBENZELL, GERMANY

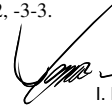

I. MORI

ONKYO EUROPE ELECTRONICS GmbH

Memory backup

The CR-505DAB uses a battery-less memory backup system in order to retain radio presets and other settings when it's unplugged or in case of a power failure. Although no batteries are required, the CR-505DAB must be plugged into an AC outlet in order to charge the backup system. Once it has been charged, the CR-505DAB will retain the settings for several weeks, although this depends on the environment and retention will be shorter in humid climates. The clock setting is not retained by the backup system.

Table of Contents

Introduction

Important Safety Instructions	2
Precautions	3
Features	6
Supplied Accessories	6
Before Using the CR-505DAB	7
Installing the Remote Controller Batteries.....	7
Using the Remote Controller	7
Controls & Connectors	8
Front Panel.....	8
Rear Panel	9
Remote Controller	10

Connections

Connecting Your Speakers	11
Connecting the Speaker Cords to the Speaker Connectors	11
Connecting an Antenna	12
Connecting the Indoor FM Antenna	12
Connecting the AM Loop Antenna	12
Connecting an Outdoor FM Antenna.....	13
Connecting an Outdoor AM Antenna	13
Connecting the DAB Antenna	13
Connecting Your Other Components to the CR-505DAB	14
Before Making Any Connections	14
Connecting RI-compatible Components	15

Getting Started

Powering Up and Setting the Clock	16
Powering Up the CR-505DAB	16
ACCUCLOCK Function	16
Setting the Clock Manually	18
Displaying the Date & Time.....	18
Displaying the Time in Standby Mode.....	18
Using the CR-505DAB	19
Selecting Sound Sources	19
Adjusting the Volume	19
Using Headphones	19

CD/MP3 Playback

Playing CDs	20
Playing CDs.....	20
Selecting Tracks by Number	20
Displaying Information.....	21
Various Playback	22
Repeat Playback	22
Random Playback	22
Memory Playback.....	23

DAB

Using DAB	24
Using DAB.....	24
Ensemble Search Mode	24
Component Search Mode	25
Sorting Components.....	25
Sorted List Search Mode.....	25
Presetting Components.....	26
Preset Search Mode.....	26
Deleting Presets.....	26
Copying Preset Channels.....	27
Displaying DAB Information	27

FM/AM

Using the Radio	28
Listening to the Radio.....	28
Tuning the Radio	28
Presetting FM Stations Automatically.....	29
Presetting Stations Manually.....	29
Selecting Presets	29
Deleting Presets	30
Copying Preset Channels.....	30
RDS (Radio Data System)	30

Using Other Functions

Other Functions	31
Muting the CR-505DAB.....	31
Adjusting the Bass & Treble	31
Using Direct Mode	31
Timers	32
About the Timers	32
Setting the Timers	32
Turning Timers Off	34
Checking Timer Settings	34
Using the Sleep Timer.....	34

Appendix

Disc Notes	35
Troubleshooting	37
Specifications	40

Features

Amp

- 25W/Ch into 6 ohms (1 kHz, 10%)
- High Current, Low Impedance Drive
- Discrete Output Stage Circuitry
- Tone Control for Treble and Bass
- Tone Direct
- 3 Audio Inputs and 2 Outputs for TAPE, MD, LINE
- Optical Digital Output

CD Player

- Plays Music CDs and MP3 CDs
- Wolfson Single-Bit D/A Converter
- 20 Track Memory Playback

Tuner

- DAB Tuning
- 59 Presets for DAB
- 40 Presets for AM and FM
- Automatic FM Scan Tuning
- RDS (CT/PS/RT)

Others

- Aluminum Volume Knob & Front Panel
- **RI**-Compatible Remote Control
- 5-Mode Timer (Timer 1, 2, 3, 4/Sleep)

Supplied Accessories

Check that the following accessories are supplied with this unit.



AM loop antenna



FM indoor antenna

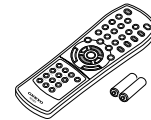

Remote controller (RC-581S)
two batteries (AAA/R03)



DAB antenna

*In catalogs and on packaging, the letter added to the end of the product name indicates the color of the CR-505DAB. Specifications and operation are the same regardless of color.

Before Using the CR-505DAB

Installing the Remote Controller Batteries

1 Open the battery compartment, as shown.

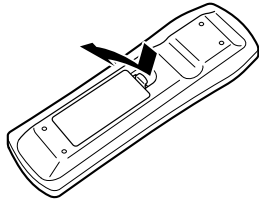

2 Insert the two supplied batteries (AAA/R03) in accordance with the polarity diagram inside the battery compartment.

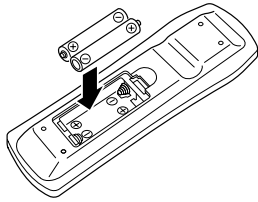

3 Close the battery compartment.

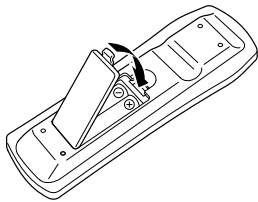

Notes:

- The supplied batteries should last for about six months, although this will vary with usage.
- If the remote controller doesn't work reliably, try replacing both batteries.
- Don't mix new and old batteries, or different types of batteries.
- If you intend not to use the remote controller for a long time, remove the batteries to prevent possible leakage and corrosion.
- Drained batteries should be removed as soon as possible to prevent possible leakage and corrosion.

Using the Remote Controller

To use the remote controller, point it at the CR-505DAB's remote control sensor, as shown below.

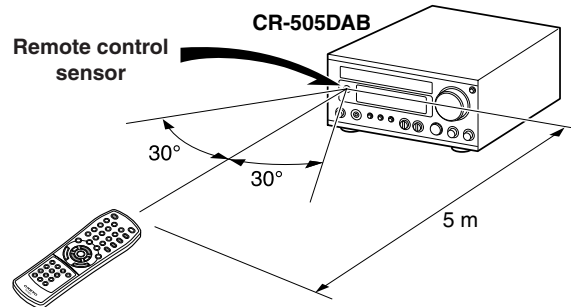

Notes:

- The remote controller may not work reliably if the CR-505DAB is subjected to bright light, such as direct sunlight or inverter type fluorescent lights. Keep this in mind when installing the CR-505DAB.
- If another remote controller of the same type is used in the same room, or the CR-505DAB is installed close to equipment that uses infrared rays, the remote controller may not work reliably.
- Don't put anything, such as a book, on the remote controller, because the buttons may be pressed inadvertently, thereby draining the batteries.
- The remote controller may not work reliably if the CR-505DAB is installed in a rack behind colored glass doors. Keep this in mind when installing the CR-505DAB.
- The remote controller will not work if there's an obstacle between it and the CR-505DAB's remote control sensor.

Controls & Connectors

Front Panel

For detailed information, refer to the pages in parentheses.

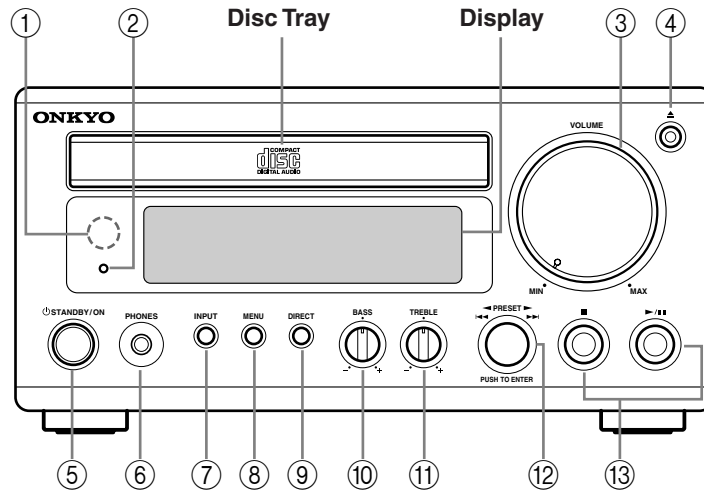

- ① **Remote control sensor (7)**
Receives control signals from the remote controller.
- ② **Standby indicator (16)**
Lights up when the CR-505DAB is in Standby mode.
- ③ **VOLUME control (19)**
Adjusts the volume.
- ④ **[▲] button (20)**
Opens and closes the disc tray.
- ⑤ **STANDBY/ON button (16)**
Sets the CR-505DAB to On or Standby.
- ⑥ **PHONES jack (19)**
Used to connect a pair of stereo headphones.
- ⑦ **INPUT selector button (19, 28)**
Used to select sound sources: CD, DAB, FM, AM, TAPE, MD or LINE.
- ⑧ **MENU button (22-30)**
Displays the Tuner menu.
Selects the play mode for CD or MP3.
- ⑨ **DIRECT button (31)**
Used to select “Tone Direct On” or “Tone Direct Off.”
- ⑩ **BASS control (31)**
Adjusts the Bass sound while the Tone Direct Off is selected.
- ⑪ **TREBLE control (31)**
Adjusts the Treble sound while the Tone Direct Off is selected.
- ⑫ **[◀▶] (PRESET [◀▶]) control (20, 23-30)**
Turn this to select the track, and push to start playing. You can also select the Preset while the FM or AM is selected.
- ⑬ **Stop [■] & Play/Pause [▶/⏸] buttons (20)**
Used to stop, start, and pause playback.

Rear Panel

For detailed information, refer to the pages in parentheses.

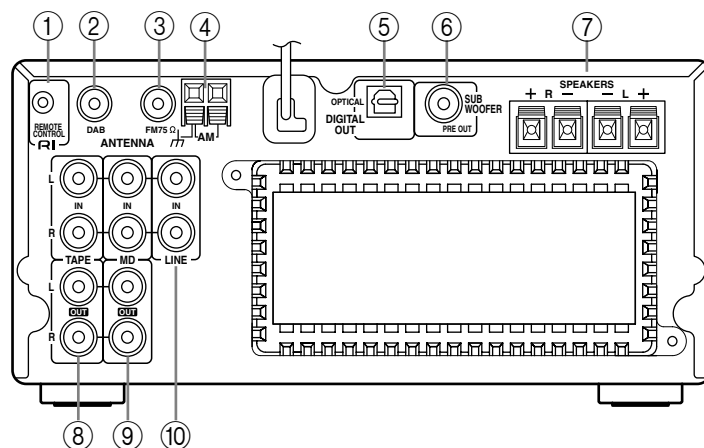

① **RI REMOTE CONTROL (15)**

This **RI** (Remote Interactive) connector can be connected to the **RI** connector on another Onkyo component. To use **RI**, you must make an analog RCA/phono connection between the CR-505DAB and your other component, even if they are connected digitally.

② **DAB ANTENNA (13)**

This connector is for connecting the supplied DAB antenna. CR-505DAB only scans UK Band III.

③ **FM 75 Ω ANTENNA (12, 13)**

This connector is for connecting an FM antenna.

④ **AM ANTENNA (12, 13)**

These push terminals are for connecting an AM antenna.

⑤ **OPTICAL DIGITAL OUT (14, 15)**

This connector can be used to connect a Mini Disc recorder or other component with digital input.

⑥ **SUBWOOFER PRE OUT (11)**

This RCA/phono connector can be used to connect an active subwoofer.

⑦ **SPEAKERS (11)**

These terminals are for connecting left and right speakers.

⑧ **TAPE IN/OUT (14)**

These RCA/phono connectors can be used to connect a cassette tape deck or other recorder with analog inputs and outputs.

⑨ **MD IN/OUT (14, 15)**

These RCA/phono connectors can be used to connect a Mini Disc recorder or other recorder with analog inputs and outputs.

⑩ **LINE IN (14)**

These RCA/phono connectors can be used to connect another component.

Remote Controller

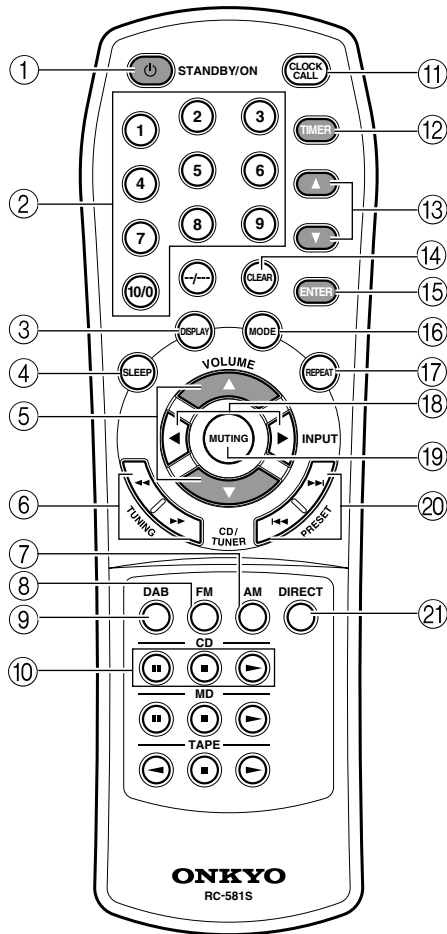

- ① **STANDBY/ON button**— Sets the CR-505DAB to On or Standby.
- ② **Number buttons**— Used to select CD tracks.
- ③ **DISPLAY button**— Used to display information.
- ④ **SLEEP button**— Used with the Sleep function.
- ⑤ **VOLUME UP [▲] & DOWN [▼] buttons**— Used to set the volume.
- ⑥ **Fast Reverse [◀◀] & Fast Forward [▶▶] buttons (TUNING buttons)**— Used for fast reverse and fast forward when playing CDs, or for tuning when using the radio.
- ⑦ **AM button**— Used to select AM tuner.
- ⑧ **FM button**— Used to select FM tuner.
- ⑨ **DAB button**— Used to select DAB tuner.
- ⑩ **CD control buttons**— Used to control CD playback.

- ⑪ **CLOCK CALL button**— Used to display the current time.
- ⑫ **TIMER button**— Used to set the timers.
- ⑬ **Up [▲] & Down [▼] buttons**— Used to set the timers.
- ⑭ **CLEAR button**— Used with memory playback.
- ⑮ **ENTER button**— Used to set the timers.
- ⑯ **MODE button**— Used to set Random Play or Memory Play.
- ⑰ **REPEAT button**— Used with repeat playback.
- ⑱ **INPUT [◀] [▶] selector buttons**— Used to select sound sources.
- ⑲ **MUTING button**— Used to mute the CR-505DAB.
- ⑳ **Previous [◀◀] & Next [▶▶] buttons (PRESET buttons)**— Used to select the previous or next track when playing CDs, or to select presets when using the radio.
- ㉑ **DIRECT button**— Used to select “Tone Direct On” or “Tone Direct Off.”

Controlling an Onkyo Cassette Tape Deck

An Onkyo Cassette Tape Deck connected via **RI** (page 15) can be controlled as follows:

1. Use the INPUT [◀]/[▶] selector buttons to select the TAPE source.
2. Use the following buttons.

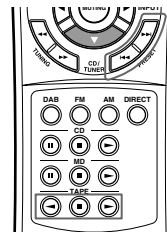

- [◀◀] Fast reverse
- [▶▶] Fast forward
- [◀] Other-side play
- [■] Stop
- [▶] Play

Controlling an Onkyo Mini Disc Recorder

An Onkyo Mini Disc Recorder connected via **RI** (page 15) can be controlled as follows:

1. Use the INPUT [◀]/[▶] selector buttons to select the MD source.
2. Use the following buttons.

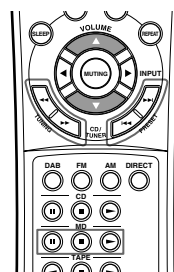

- [◀◀] Fast reverse
- [▶▶] Fast forward
- [◀◀] Previous track
- [▶▶] Next track
- [■] Pause
- [■] Stop
- [▶] Play
- [REPEAT] Repeat mode

Connecting Your Speakers

Before you connect your speakers, read the following:

- Disconnect the power cord from the wall outlet.
- Read the instructions supplied with your speakers.
- Pay close attention to speaker wiring polarity. In other words, connect positive (+) terminals only to positive (+) terminals, and negative (-) terminals only to negative (-) terminals. If you get them the wrong way around, the sound will be out of phase and will sound odd.
- Only use speakers with an impedance of 4 ohms or higher. If you use speakers with a lower impedance, and use the amplifier at high volume levels for a long period of time, the built-in protection circuit may be activated.
- Unnecessarily long or very thin speaker cables may affect the sound quality and should be avoided.
- Be careful not to short the positive and negative connections. Doing so may damage the CD Receiver.
- Don't connect more than one cable to each speaker terminal. Doing so may damage the CD Receiver.
- If you want to connect a single speaker instead of a pair, connect it to either the left or right speaker terminals, not both.

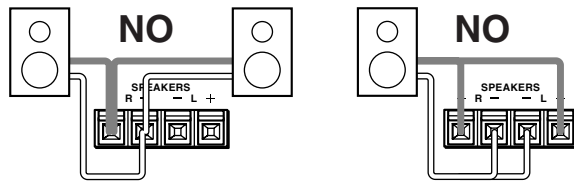
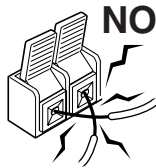

Connecting the Speaker Cords to the Speaker Connectors

1 Strip 10 mm from the end of each cord.

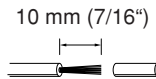

2 Twist the stripped end of the cord.

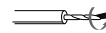

3 Push the lever up.

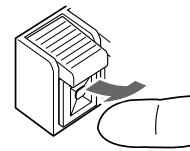

4 Insert the stripped end of the cord.

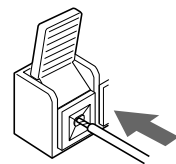

5 Press down the lever. The wire of the stripped end of the cord should appear slightly.

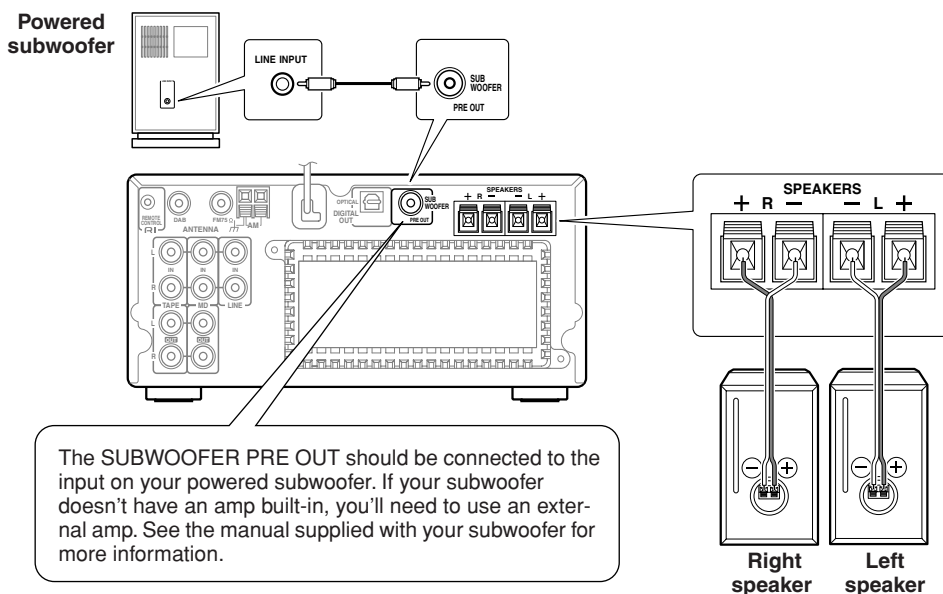
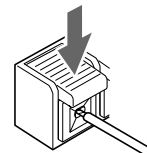

Connecting an Antenna

This chapter explains how to connect the supplied indoor FM antenna, AM loop antenna, and DAB antenna and how to connect commercially available outdoor FM and AM antennas.

The CD Receiver won't pick up any radio signals without any antenna connected, so you must connect an antenna to use the tuner.

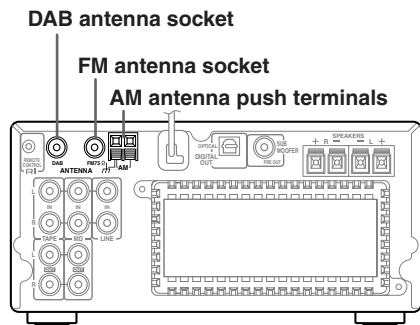

Connecting the Indoor FM Antenna

The supplied indoor FM antenna is for indoor use only.

1 Attach the FM antenna, as shown.

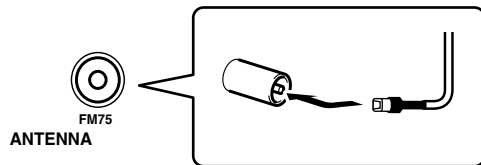

Once the CD Receiver is ready for use, you'll need to tune into an FM radio station and adjust the position of the FM antenna to achieve the best possible reception.

2 Use thumbtacks or something similar to fix the FM antenna into position.

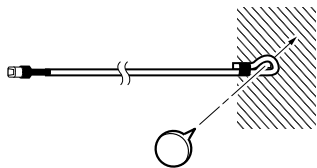

Caution: Be careful that you don't injure yourself when using thumbtacks.

If you cannot achieve good reception with the supplied indoor FM antenna, try using a commercially available outdoor FM antenna instead (see page 13).

Connecting the AM Loop Antenna

The supplied indoor AM loop antenna is for indoor use only.

1 Assemble the AM loop antenna, inserting the tabs into the base, as shown.

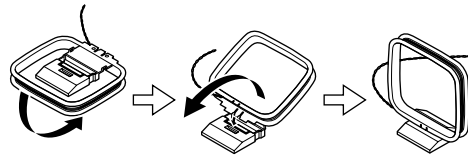

2 Connect both wires of the AM loop antenna to the AM push terminals, as shown.

(The antenna's wires are not polarity sensitive, so they can be connected in either push terminal.)

Make sure that the wires are attached securely and that the push terminals are gripping the bare wires, not the insulation.

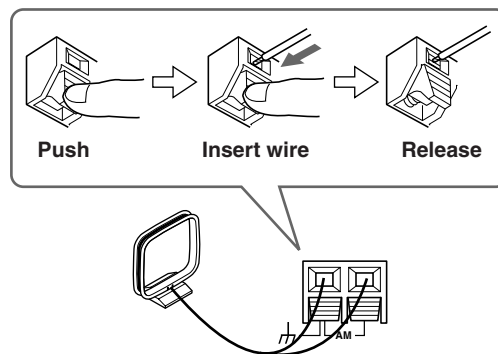

Once the CD Receiver is ready for use, you'll need to tune into an AM radio station and adjust the position of the AM antenna to achieve the best possible reception. Keep the antenna as far away as possible from the CD Receiver, TV, speaker cables, and power cords.

If you cannot achieve good reception with the supplied indoor AM loop antenna, try using a commercially available outdoor AM antenna (see page 13).

Connecting an Outdoor FM Antenna

If you cannot achieve good reception with the supplied indoor FM antenna, try using a commercially available outdoor FM antenna instead.

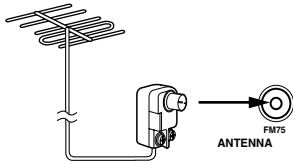

Notes:

- Outdoor FM antennas work best outside, but usable results can sometimes be obtained when installed in an attic or loft.
- For best results, install the outdoor FM antenna well away from tall buildings, preferably with a clear line of sight to the transmitter.
- Outdoor antennas should be located away from possible noise sources, such as neon signs, busy roads, etc.
- For safety reasons, an outdoor antenna should be situated well away from power lines and other high-voltage equipment.
- Outdoor antennas must be grounded in accordance with local regulations to prevent electrical shock hazards.

■ **Using a TV/FM Antenna Splitter**

It's best not to use the same antenna for both FM and TV reception, as this can cause interference problems. If circumstances demand it, use a TV/FM antenna splitter, as shown.

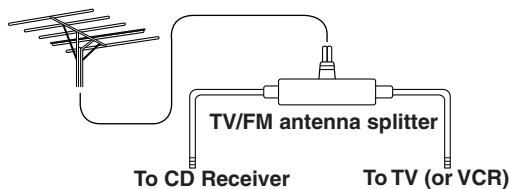

Connecting an Outdoor AM Antenna

If good reception cannot be achieved using the supplied AM loop antenna, an outdoor AM antenna can be used in addition to the loop antenna, as shown.

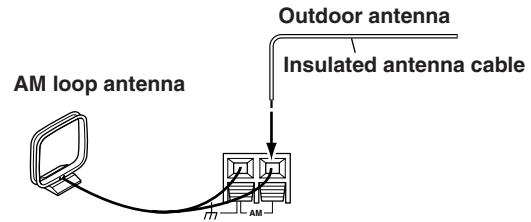

Outdoor AM antennas work best when installed horizontally outside, but good results can sometimes be obtained indoors by mounting it horizontally above a window. Note that the AM loop antenna should be left connected. Outdoor antennas must be grounded in accordance with local regulations to prevent electrical shock hazards.

Connecting the DAB Antenna

- 1 **Screw the supplied DAB antenna onto the DAB connector.**

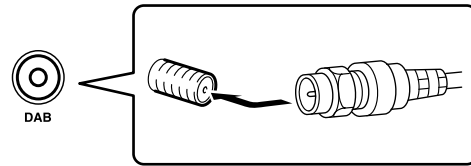

Once the CD Receiver is ready for use, you'll need to tune into a DAB station and adjust the position of the DAB antenna to achieve the best possible reception.

- 2 **Use thumbtacks or something similar to fix the DAB antenna into position.**

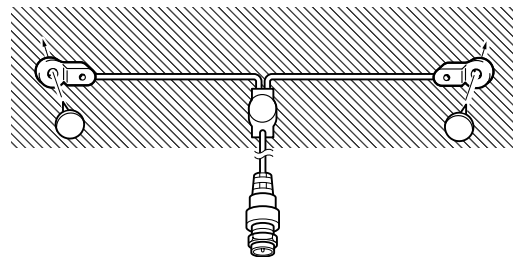

Connecting Your Other Components to the CR-505DAB

Before Making Any Connections

- Read the manuals supplied with your components.
- Don't connect the power cord until you've completed and double-checked all connections.

Optical Digital Output

The CD Receiver's optical digital output has a shutter-type cover that opens when an optical plug is inserted and closes when it's removed. Push a plug in all the way.

Caution: To prevent shutter damage, hold the optical plug straight when inserting and removing.

RCA Connection Color Coding

RCA-type connections are usually color coded: red and white. Use red plugs to connect right-channel audio inputs and outputs (typically labeled "R"). Use white plugs to connect left-channel audio inputs and outputs (typically labeled "L").

Analog audio

Left (white) Right (red)

- Push plugs in all the way to make good connections (loose connections can cause noise or malfunctions).
- To prevent interference, keep audio cables away from power cords and speaker cables.

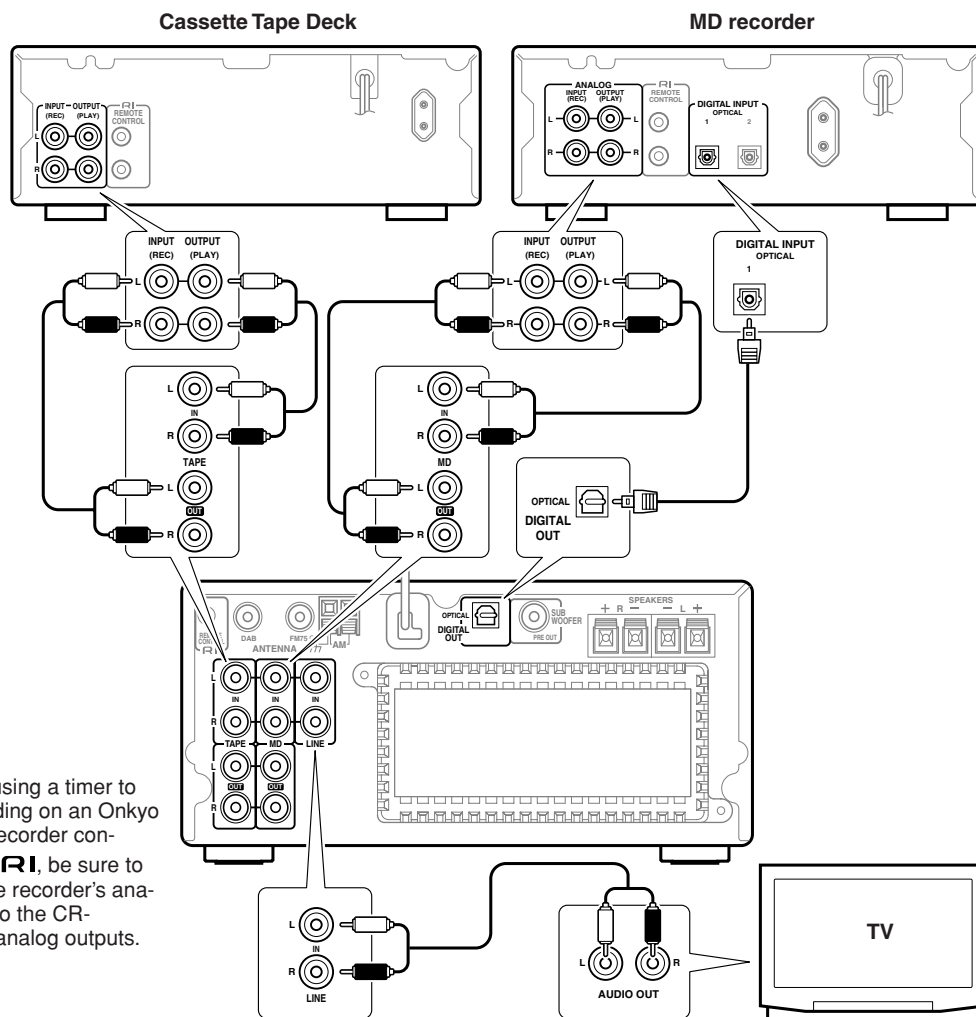
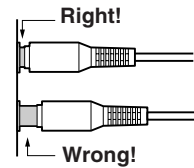

Note: If you are using a timer to start recording on an Onkyo Mini Disc recorder connected via **RI**, be sure to connect the recorder's analog inputs to the CR-505DAB's analog outputs.

Connecting RI-compatible Components

With **RI** (Remote Interactive) you can control your **RI**-compatible Onkyo cassette tape deck or MD recorder with the CR-505DAB's remote controller, and use the following special **RI** functions:

■ Auto Power On

When you turn on a component connected via **RI** while the CR-505DAB is in Standby, the CR-505DAB automatically turns on and selects that component as the input source. This function doesn't work if the CR-505DAB is already on.

■ Direct Change

When you press the play button on a component connected via **RI**, the CR-505DAB automatically selects that component as the input source.

■ Auto Power Off

When you set the CR-505DAB to Standby, all components connected via **RI** also enter Standby.

■ Controlling Other Components

Other components can be controlled with the supplied remote controller (see "Remote Controller" on page 10).

■ CD Synchro Recording

An MD recorder or cassette tape deck connected via **RI**, and set to record/pause, will start recording automatically when CD playback is started on the CR-505DAB.

■ Timer

The CR-505DAB's timers can be used to automatically start playback or recording on a cassette tape deck or MD recorder connected via **RI** (see "Timers" on page 32).

■ Sleep Timer

When you set the CR-505DAB's sleep timer, the sleep timers on component connected via **RI** are also set, so all components switch off after the specified period.

To use **RI**, you need to connect the CR-505DAB's **RI** connector to an **RI** connector on the other component by using an **RI** cable. An **RI** cable is supplied with each **RI**-compatible Onkyo cassette tape deck and MD recorder.

RI Hookup Example:

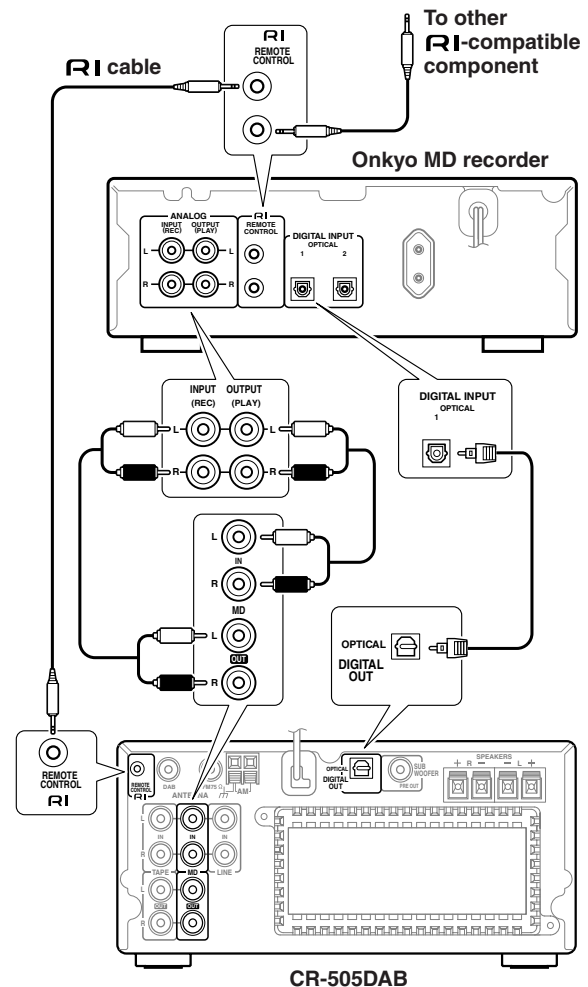

Notes:

- Use only **RI** cables for **RI** connections.
- **To use RI you must make an analog RCA/phono connection between the CR-505DAB and the other component even if they are connected digitally.**
- If a component has two **RI** connectors, you can connect either one to the CR-505DAB. The other connector is for connecting additional **RI**-compatible components.
- Connect the CR-505DAB's **RI** connector only to Onkyo components. Connecting to other manufacturer's components may cause them to malfunction.
- Some Onkyo **RI**-compatible components may not support the special functions described above.

Powering Up and Setting the Clock

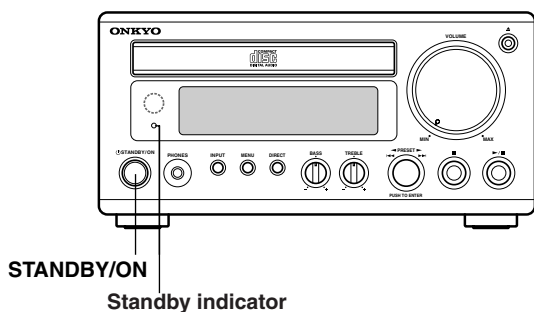

Powering Up the CR-505DAB

Before connecting the power cord, complete all connections (see pages 11 to 15).

1 Connect the power cord to a suitable wall outlet.

The CR-505DAB enters Standby mode, and the Standby indicator comes on.

2 To turn on the CR-505DAB, press the [STANDBY/ON] button.

The CR-505DAB comes on, the display lights up, and the Standby indicator goes off.

To turn off the CR-505DAB, press the [STANDBY/ON] button again. The CR-505DAB enters Standby mode and the Standby indicator comes on.

ACCUCLOCK Function

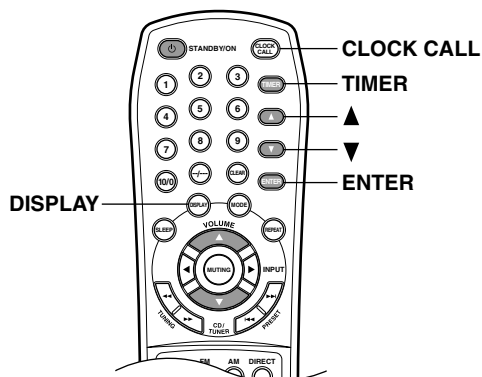

The very first time you turn on the CR-505DAB, the ACCUCLOCK function automatically sets the clock by using the CT (Clock Time) information present in RDS radio broadcasts.

While the clock is being set, “Clock Setting” appears on the display, as shown. It may take a while to set the clock.

Clock Setting

When the clock has been set, “Adjusted” appears on the display for a while.

Use the [CLOCK CALL] button to check if the clock has been set correctly.

If the clock has not been set correctly, see “Setting the Clock Manually” on page 18.

The ACCUCLOCK function automatically calibrates the clock daily at 2 AM, 3 AM and 2 PM.

If ACCUCLOCK does not stop:

When the radio reception is not good, the ACCUCLOCK function may not end. To force the ACCUCLOCK function to end, press the [DISPLAY] button. In this case, set the clock manually.

If the wrong day or time appears on the display:

If you live close to the border with another country, the CT information may have been taken from a radio station in another time zone. In this case you should specify another station and try setting again (see “Setting ACCUCLOCK to Use a Specific Station” on page 17).

Powering Up and Setting the Clock—Continued

■ Setting ACCUCLOCK to Use a Specific Station

If the wrong time is displayed, you can specify which FM station the ACCUCLOCK function should use. This must be an FM station that supports RDS CT (Clock Time) information.

- 1 Press the [FM] button to select FM.
- 2 Press the [TIMER] button repeatedly until “Clock” appears.
- 3 Press the [ENTER] button.
“Accuclock” appears on the display.
If “Manual Adjust” appears, use the Up/Down [▲]/[▼] buttons to select “Accuclock.”
- 4 Press the [ENTER] button.
“Auto” appears on the display.
- 5 Use the Up/Down [▲]/[▼] buttons to select “Station” and press [ENTER].
- 6 Use the [◀]/[▶] buttons to tune into the FM station.
The “RDS” indicator appears when tuned into a station that supports RDS.



```
FM AC      RDS
87.80MHz
```

7 Press the [ENTER] button.

While the clock is being set, “Clock Setting” appears on the display. It may take a few minutes to set the clock.

When the clock has been set, “Adjusted” appears on the display for a while.

Notes:

- If the clock has not been set correctly, specify another FM station and try again, or set the clock manually (see page 18).
- If you don't want the clock to be calibrated automatically, you can turn off the ACCUCLOCK function (see the next section).

■ Turning Off ACCUCLOCK

If you don't want ACCUCLOCK to calibrate the clock automatically at 2 AM, 3 AM and 2 PM everyday, you can turn it off as follows.

- 1 Press the [FM] button to select FM.
- 2 Press the [TIMER] button repeatedly until “Clock” appears on the display, as shown.

```
Clock
```
- 3 Press the [ENTER] button.
“Accuclock” appears on the display.
- 4 Use the Up/Down [▲]/[▼] buttons to select “Manual Adjust.”
- 5 Press the [ENTER] button 3 times.

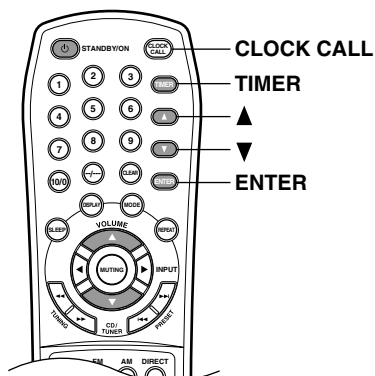

Setting the Clock Manually

If you cannot set the clock by using the ACCUCLOCK function, you can set it manually. In this case, the ACCUCLOCK function will not automatically calibrate the clock each day.

- 1 Press the [TIMER] button repeatedly until “Clock” appears.

Clock

- 2 Press the [ENTER] button and use the Up/Down [▲]/[▼] buttons to select “Manual Adjust.”

Manual Adjust

- 3 Press the [ENTER] button.
The day of the week flashes.

- 4 Use the Up/Down [▲]/[▼] buttons to select a day.

SUN 0:00

- 5 Press the [ENTER] button.

The time flashes.

- 6 Use the Up/Down [▲]/[▼] buttons to set the time.

SUN 19:03

- 7 Press the [ENTER] button to set the clock.

“Adjusted” appears on the display.

Displaying the Date & Time

- 1 Press the [CLOCK CALL] button.

The date and time appear on the display.

Press the [CLOCK CALL] button again to return to the previous display.

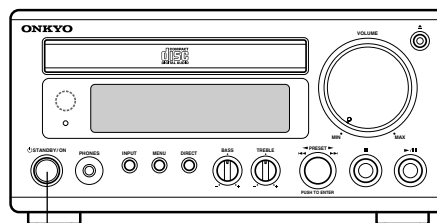

STANDBY/ON

Displaying the Time in Standby Mode

You can set the CR-505DAB so that the time is displayed while the CR-505DAB is in Standby mode.

- 1 With the CR-505DAB turned on, press and hold the CR-505DAB’s [STANDBY/ON] button for more than 2 seconds.

To turn off the time display, repeat this procedure.

Note:

Setting the CR-505DAB to display the time will slightly increase the power consumption in Standby mode.

Using the CR-505DAB

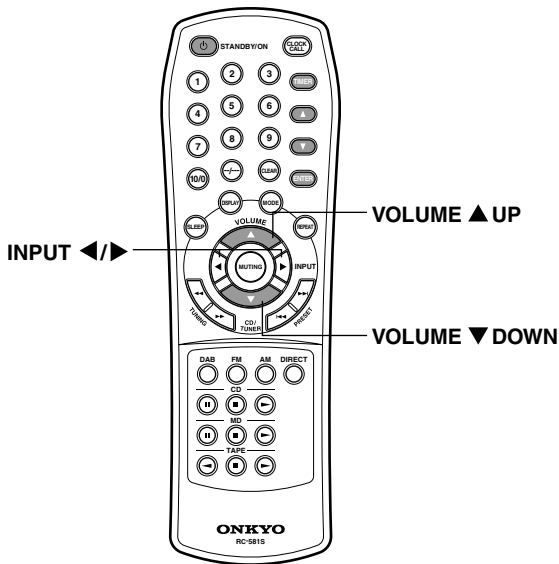
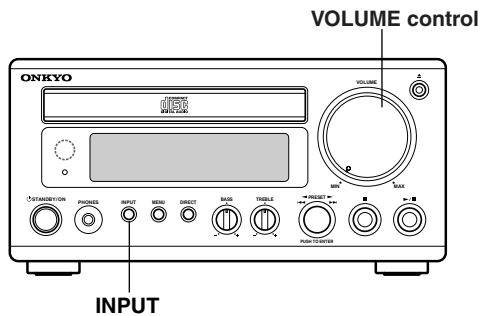

Adjusting the Volume

To adjust the volume, use the [VOLUME] control, or the remote controller's VOLUME [▲]/[▼] buttons.

Turn the [VOLUME] control clockwise to increase the volume; counterclockwise to decrease it.

Using Headphones

You can connect a pair of stereo headphones to the CR-505DAB's PHONES jack for private listening, as shown.

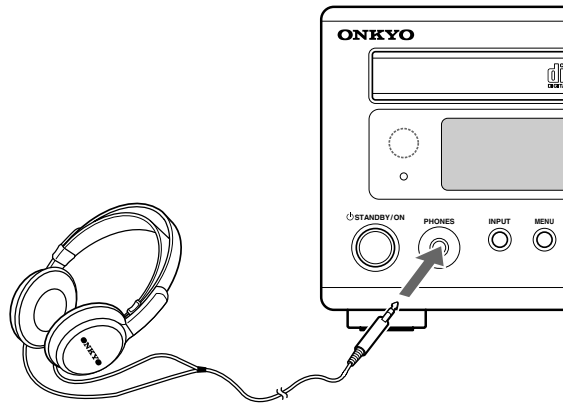

Note:

Always turn down the volume before connecting your headphones.

Selecting Sound Sources

Use the [INPUT] button, or the remote controller's INPUT [◀]/[▶] buttons to select one of the following sound sources: CD, DAB, FM or AM, TAPE, MD, LINE.

The currently selected source is shown on the display.

2 If you selected CD, see "Playing CDs" on page 20.

If you select DAB, see "Using DAB" on page 24.

If you selected AM or FM, see "Using the Radio" on page 28.

If you selected TAPE, MD, or LINE, start playback on the relevant component.

Playing CDs

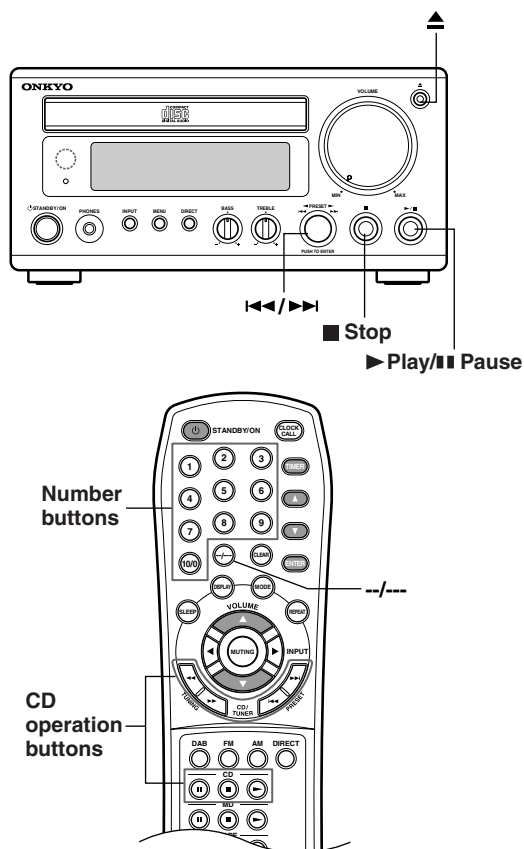

■ To Fast Forward or Fast Reverse (remote controller only)

During playback or while playback is paused, press and hold the [▶▶] button to fast forward, or the [◀◀] button to fast reverse.

For MP3, fast reverse only works within the MP3 track that is currently playing.

If you press the button for more than four seconds, the fast forward or fast reverse speed increases.

■ To Select Tracks

On the CR-505DAB:

Turn the [◀◀/▶▶] control to select a track for playback. If you select a track while playback is stopped, press the [◀◀/▶▶] control to start playback.

Press the [◀◀/▶▶] control to jump to the next track during playback.

On the remote controller:

Press the [▶▶] button to select the next track, or the [◀◀] button to select the previous track.

If you press the [◀◀] button during playback or while playback is paused, the beginning of the current track is selected.

If you select a track while playback is stopped, press the Play [▶] button to start playback.

Note:

With CDs and MP3 discs that contain many tracks, playback may take a while to start.

Playing CDs

1 Press the [▲] button to open the disc tray, put the CD on the tray with the label-side facing up, and press the [▲] button again to close the tray.



Be sure to put 8 cm discs in the center of the tray.

2 Press the Play [▶] button to start playback.

Playback starts and the Play ▶ indicator appears on the display.

■ To Stop Playback

- Press the Stop [■] button.

■ To Pause Playback

- Press the Play/Pause [▶/■] button on the CR-505DAB or Pause [■] button on the remote controller. The Pause ■ indicator appears.
- To resume playback, press the Play/Pause [▶/■] button on the CR-505DAB or Play [▶] button on the remote controller.

Selecting Tracks by Number

You can use the number buttons to select specific tracks.

■ Use the number buttons to enter a track number. Playback starts automatically.

For MP3 disc, select the serial number assigned to the track.

To enter a track number smaller than or equal to 10, press each number button. For example, to enter track number 10, press [10/0].

Use the [--/--] button to enter track numbers above 10. To enter a track number from 11 to 99, press [--/--] once. For example, to enter track number 15, press [--/--], [1] and [5].

To enter a track number greater than or equal to 100, press [--/--] twice. For example, to enter track number 123, press [--/--] twice, [1], [2] and [3].

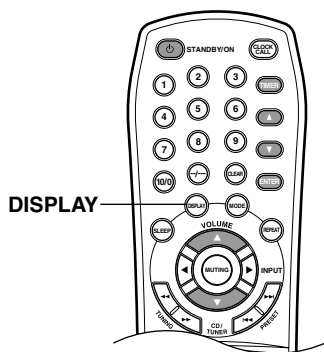

Displaying Information

This section explains how to display various information, including the remaining track time, remaining disc time, and ID3 tag for MP3 tracks.

During playback, press the [DISPLAY] button repeatedly to cycle through the following options.

Audio CD

Elapsed track time: The length of time that the current track has been playing (default display).



Remaining track time: The amount of time remaining for the current track (“R” indicator appears).



Remaining disc time: The amount of time remaining for the entire disc (“T” indicator appears).



MP3 Disc

Elapsed track time: The length of time that the current track has been playing (default display).



Track name: Name of the current track.



Folder name: Name of the current folder.



Title name: Title of the current track (if ID3 tag present).

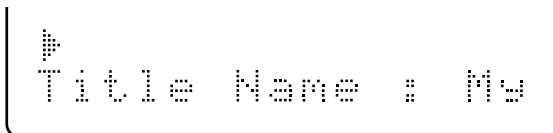

Notes:

- To display the disc name, while playback is stopped, press the [DISPLAY] button.
- If a track or folder name contains a character that cannot be displayed, it will be displayed as “*.”

Various Playback

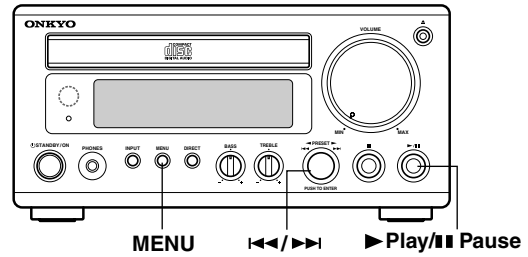
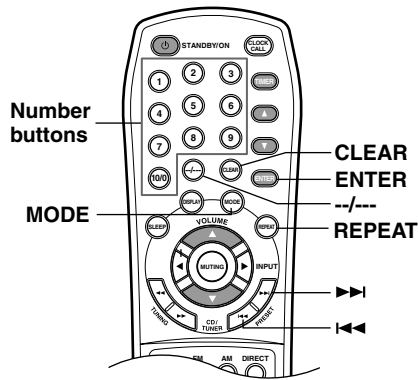

Repeat Playback

With the Repeat function you can play a track, a folder or a disc repeatedly.

1 During playback, press the remote controller's [REPEAT] button repeatedly to select repeat mode.

D-Rpt: Repeat the disc



T-Rpt: Repeat current track



F-Rpt: Repeat current folder (MP3 only)



2 To cancel Repeat playback, press the [REPEAT] button repeatedly to turn off the "Rpt" indicator.

Note:

If you press the [REPEAT] button during memory playback, your custom program will play repeatedly.

Random Playback

With the Random function you can play tracks in random order.

1 While stopped, press the remote controller's [MODE] button repeatedly to display "D-Rdm" indicator.



2 Press the Play [▶] button to start random playback.

All tracks are played in random order.

3 To cancel random playback, stop playback, and then press the [MODE] button repeatedly until the "Rdm" indicator disappears.

Note:

When carrying out operations on the CR-505DAB, press the [MENU] button repeatedly to select the RANDOM mode, and then press the Play/Pause [▶/||] button to start random playback.

Memory Playback

With the Memory function you can make a custom program of your favourite tracks.

1 While stopped, press the remote controller's [MODE] button repeatedly until the "Mem" indicator appears on the display.

2 To add a track to your program, use the [◀◀]/[▶▶] buttons to select it, and then press the [ENTER] button.

You can add up to 20 tracks to your program.

Tracks can also be added by using the number buttons. For information on using the number buttons to select a track, see "Selecting Tracks by Number" on page 20.

You can check which tracks you've added to the program by using the [◀◀]/[▶▶] buttons.



3 To start memory playback, press the Play [▶] button.

Memory playback stops automatically when all the tracks in the program have been played.

Note:

When carrying out operations on the CR-505DAB, press the [MENU] button repeatedly to turn on the "Mem" indicator, turn the [◀◀]/[▶▶] control to select a track, and press the [◀◀]/[▶▶] control to register. To start memory playback, press the Play/Pause [▶/■] button.

■ To Stop Memory Playback

Press the Stop [■] button.

■ To Remove the Last Track in the Program

While memory playback is stopped, press the [CLEAR] button. Each time you press it the last track in the program is removed.

■ To Cancel Memory Playback

While memory playback is stopped, press the [MODE] button repeatedly until the "Mem" indicator disappears. The entire program will be deleted.

Notes:

- If the total playing time of your program exceeds 99 minutes and 59 seconds, "--:--" is displayed. (This does not affect program playback.)
- The program is deleted when the disc tray is opened.

Using DAB

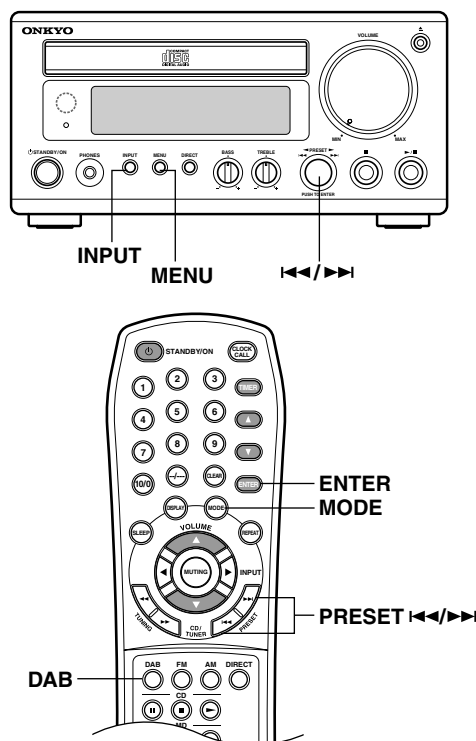

Using DAB

- 1 Press the [DAB] button on the remote controller, or press the [INPUT] button on the CR-505DAB repeatedly to select DAB input.

DAB

Using the DAB for the first time:

When you first switch on the unit and select DAB, the Auto Tuning function scans the Band III frequencies.

After the scanning, the first scanned component will be selected and you will hear it through your speakers.

To listen to other stations, use one of the search modes shown below.

- **Ensemble search mode:** Selects the frequency (Ensemble) (Page 24).
- **Component search mode:** Searches the components (Page 25).
- **Sorted List search mode:** Searches in the sorted order in the selected sort mode (Page 25).
- **Preset search mode:** Searches the preset components (Page 26).

You can use the Auto Tuning function manually:

You may want to re-tune at a later date if you move the CR-505DAB or if you want to receive a newly introduced ensemble.

1. Press the [MENU] button.
2. Turn the [◀/▶] control to select “Auto Tuning” and push the [◀/▶] control.
3. The Auto Tuning starts and scans the Band III frequencies. The number of scanned components are shown during scanning.

Notes:

- You can also control this function using the [MODE], PRESET [◀/▶] and [ENTER] buttons on the remote controller.
- During BAND III scanning, the DAB only scans the audio services in the 174.928-239.200 MHz band range.

About secondary service:

If a secondary service exists, the “>>” symbol will light up in the “Ensemble No. & Freq.” Press the [ENTER] button to select the secondary service.

While the secondary service is selected, the “<<” symbol will light up on the display. Press the [ENTER] button to go back to the primary service.

Ensemble Search Mode

You can select any frequency (ensemble) scanned by using the Auto Tuning function.

- 1 Press the [MENU] button.
- 2 Turn the [◀/▶] control to select “Search Mode” and push the [◀/▶] control.
- 3 Turn the [◀/▶] control to select “Ensemble” and push the [◀/▶] control.

Search Mode
Ensemble

- 4 Turn the [◀/▶] control to select an ensemble.

Component Search Mode

You can select a component for listening from the list of scanned components produced by using the Auto Tuning function.

- 1 Press the [MENU] button.
- 2 Turn the [◀/▶] control to select “Search Mode” and push the [◀/▶] control.
- 3 Turn the [◀/▶] control to select “Component” and push the [◀/▶] control.

```
Search Mode
Component
```

- 4 Turn the [◀/▶] control to select the component you require.

You can select any component outside the ensemble.

Sorted List Search Mode

You can select any component for listening from the list of sorted components.

- 1 Press the [MENU] button.
- 2 Turn the [◀/▶] control to select “Search Mode” and push the [◀/▶] control.
- 3 Turn the [◀/▶] control to select “Sorted List” and push the [◀/▶] control.

```
Search Mode
Sorted List
```

- 4 Turn the [◀/▶] control to select a component and push the [◀/▶] control.

You can select any component from the sorted list.

Sorting Components

You can sort and list scanned components by component name, program type or alphabetical order.

You can then select the component you want to listen to from the list.

- **Component Name**

Sorts the components for each ensemble by component name.

- **PTY**

Sorts components by program type.

- **Alphabet**

Sorts component names in alphabetical order.

- 1 Press the [MENU] button.
- 2 Turn the [◀/▶] control to select “Sort Mode” and push the [◀/▶] control.

```
Please Select
Sort Mode
```

- 3 Turn the [◀/▶] control to select the sort mode required and push the [◀/▶] control.

Components are sorted in the sort mode selected.

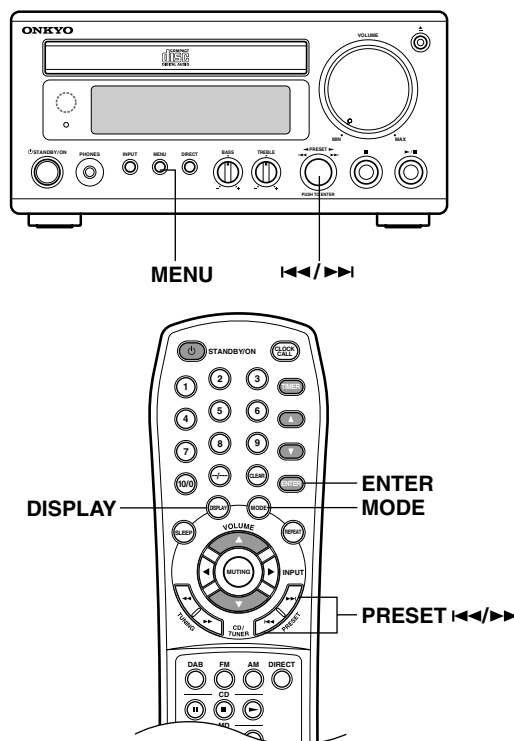

Presetting Components

You can preset up to 59 of your favourite DAB components.

- 1** Search for your favourite DAB component.
- 2** Press the [MENU] button.
- 3** Turn the [◀▶] control to select “Preset Edit” and push the [◀▶] control.
- 4** Turn the [◀▶] control to select “Preset Write?” and push the [◀▶] control.
The preset number flashes.

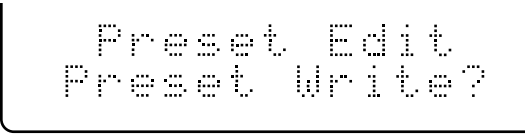

- 5** While the preset number is flashing, use the [◀▶] control to select a preset number from 1 to 59.
- 6** Press the [◀▶] control to store the station.
Repeat this procedure to store all your favourite stations in the presets.

Preset Search Mode

You can select previously stored presets as follows.

- 1** Press the [MENU] button.
- 2** Turn the [◀▶] control to select “Search Mode” and push the [◀▶] control.
- 3** Turn the [◀▶] control to select “Preset” and push the [◀▶] control.



- 4** Turn the [◀▶] control to select a preset.

Deleting Presets

You can delete unwanted presets as follows.

- 1** Select the preset that you want to delete.
- 2** Press the [MENU] button.
- 3** Turn the [◀▶] control to select “Preset Edit” and push the [◀▶] control.
- 4** Turn the [◀▶] control until “Preset Erase?” appears on the display.



- 5** Push the [◀▶] control.
The selected preset is deleted.

Copying Preset Channels

You can copy a preset channel to another channel.

- 1 Select the preset that you want to copy.**
- 2 Press the [MENU] button.**
- 3 Turn the [◀/▶] control to select “Preset Edit” and push the [◀/▶] control.**
- 4 Turn the [◀/▶] control until “Preset Copy?” appears on the display.**

```
Preset Edit
Preset Copy?
```
- 5 Push the [◀/▶] control.**
The preset number flashes.
- 6 While the preset number is flashing, use the [◀/▶] control to select a preset number from 1 to 59.**
- 7 Push the [◀/▶] control.**
The station is copied to another channel and the preset number stops flashing.

Displaying DAB Information

Press the [DISPLAY] button repeatedly to cycle through the seven different display modes.

1. P-Type (Service Components)

Displays a description of the program type being broadcast by the station.

```
BBC Radio 1
Pop Music
```

2. Time

Displays the date and time obtained from the current component.

```
BBC Radio 1
19:03 07/03/2004
```

3. Bit Rate + mono/stereo

Displays the current station mode (stereo or mono) and the bit rate at which the audio signal is being transmitted. This rate is set by the broadcaster to suit the type and quality of material being transmitted.

```
BBC Radio 1
128kbps Stereo
```

4. Bit Error Rate

Noise may be generated and reception quality may become poor at bit error rates above 0.1. If a rate above 0.1 is displayed, move the antenna in different directions to find a position where the rate displayed is less 0.1.

```
BBC Radio 1
BER:0.0149
```

5. DLS (Data Label Service)

Displays any scrolling text transmitted with the audio signal.

```
BBC Radio 1
* This Program
```

6. Ensemble Name

Displays the ensemble name.

```
BBC Radio 1
BBC National DAB
```

7. Ensemble No. & Freq

Displays the ensemble number and frequency for the station to which you are tuned.

```
BBC Radio 1
12B 225.648MHz
```

Using the Radio

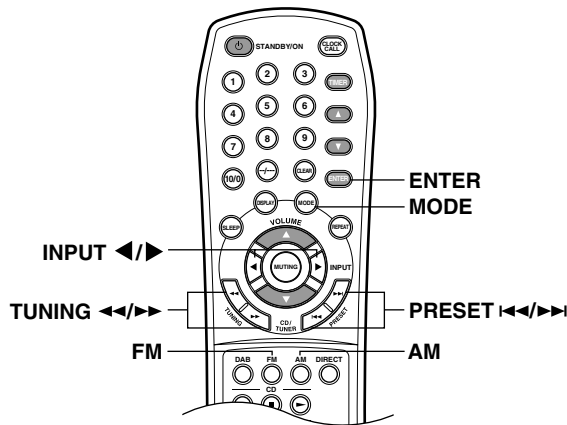
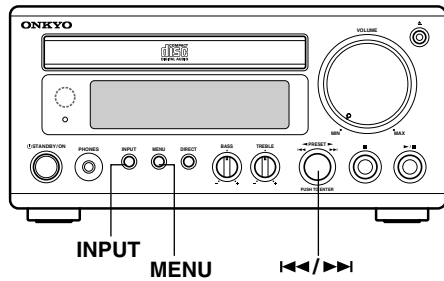

■ Tuning into weak FM stations

If a station has poor signal strength, you may not be able to tune into that station properly, or reception may be noisy. In this case, switch the FM Mode to Mono, then tune the band.

Switching the FM Mode to Mono:

- 1 Press the [MODE] button.
- 2 Use the [◀◀]/[▶▶] buttons to display “FM Mode” and press [ENTER].
- 3 Use [◀◀]/[▶▶] to display “Mono” and press [ENTER].
The “ST” (FM stereo) indicator goes off and mono mode is selected.

Using the buttons on the CR-505DAB:

1. Press the [MENU] button.
2. Turn the [◀◀/▶▶] control until “FM Mode” appears on the display and push the [◀◀/▶▶] control.
3. Turn the [◀◀/▶▶] control until “Mono” appears on the display and push the [◀◀/▶▶] control.

Listening to the Radio

- 1 Press the [AM] or [FM] button to select AM or FM. Or use the [INPUT] button, or the remote controller’s INPUT [◀/▶] buttons to select AM or FM.

Tuning the Radio

- 1 Press and hold the TUNING [◀◀] or [▶▶] button on the remote controller for more than one second and then release it.
The CR-505DAB searches for the next station. Searching stops when a station is found.

- 2 Use the TUNING [◀◀]/[▶▶] buttons for fine tuning.

Note:

You can tune the radio with the remote controller only.

If you select the FM band:

When you’re tuned into a station, the Tuned ▶●◀ and “ST” (FM stereo) indicators appear.

The FM band is searched in 0.05 MHz intervals.

If you select the AM band:

When you’re tuned into a station, the Tuned ▶●◀ indicator appears.

The AM band is searched in 9 kHz intervals.

Presetting FM Stations Automatically

With the Auto Preset function you can automatically preset all the FM stations available in your area.

- 1 Press the [FM] button.
- 2 Press the [MODE] button.
- 3 Use the [◀]/[▶] buttons to display “Preset Edit,” and then press the [ENTER] button.
- 4 Use the [◀]/[▶] buttons to display “Auto Preset?,” and then press the [ENTER] button.

Preset Edit
Auto Preset?

Auto Preset function starts.

The Auto Preset function scans the FM band from low to high, presetting up to 30 stations with strong signals.

Note:

All previously stored presets will be overwritten when the Auto Preset function is used again.

Using the buttons on the CR-505DAB:

1. Use the [INPUT] button to select FM.
2. Press the [MENU] button.
3. Turn the [◀/▶] control until “Preset Edit” appears on the display and then push the [◀/▶] control.
4. Turn the [◀/▶] control until “Auto Preset?” appears on the display and then push the [◀/▶] control.

Presetting Stations Manually

You can preset up to 40 of your favourite AM and FM radio stations.

- 1 Tune into the station that you want to store as a preset.
- 2 Press the [MODE] button.
- 3 Use the [◀]/[▶] buttons to display “Preset Edit,” and then press the [ENTER] button.

- 4 Use the [◀]/[▶] buttons to display “Preset Write?,” and then press the [ENTER] button.

The preset number flashes.

Preset Edit
Preset Write?

- 5 While the preset number is flashing, use the [◀]/[▶] buttons to select a preset number from 1 to 40.

You cannot choose any preset number that has already been registered for either the FM or AM station.

- 6 Press the [ENTER] button to store the station.

The station is stored and the preset number stops flashing.

Repeat this procedure for all of your favourite radio stations.

Note:

When the CR-505DAB is tuned into a station that’s transmitting PS (Program Service Name) RDS information, the station’s name will be displayed instead of the frequency.

Using the buttons on the CR-505DAB:

1. Tune into the station that you want to store as a preset.
2. Press the [MENU] button.
3. Turn the [◀/▶] control until “Preset Edit” appears on the display and then push the [◀/▶] control.
4. Turn the [◀/▶] control until “Preset Write?” appears on the display and push the [◀/▶] control.
5. While the preset number is flashing, use the [◀/▶] control to select a preset number from 1 to 40.
6. Press the [◀/▶] control to store the station.

Selecting Presets

You can select previously stored presets as follows.

Using the CR-505DAB

- 1 Turn the [◀/▶] control to select presets.

Using the remote controller

- 1 Use the PRESET [◀]/[▶] buttons to select presets.

Deleting Presets

You can delete unwanted presets as follows.

- 1 Select the preset that you want to delete.
- 2 Press the [MODE] button and use the [◀]/[▶] buttons to display “Preset Edit.”
- 3 Press the [ENTER] button.
- 4 Use the [◀]/[▶] buttons to display “Preset Erase?”

```
Preset Edit
Preset Erase?
```

- 5 Press the [ENTER] button.

The selected preset is deleted and its number disappears from the display.

Using the buttons on the CR-505DAB:

1. Select the preset that you want to delete.
2. Press the [MENU] button and turn the [◀/▶] control until “Preset Edit” appears on the display.
3. Push the [◀/▶] control.
4. Turn the [◀/▶] control until “Preset Erase?” appears on the display.
5. Push the [◀/▶] control.

Copying Preset Channels

You can copy a preset channel to another channel.

- 1 Select the preset that you want to copy.
- 2 Press the [MODE] button and use the [◀]/[▶] buttons to display “Preset Edit.”
- 3 Press the [ENTER] button.
- 4 Use the [◀]/[▶] buttons to display “Preset Copy?”

```
Preset Edit
Preset Copy?
```

- 5 Press the [ENTER] button.

The preset number flashes.

- 6 While the preset number is flashing, use the [◀]/[▶] buttons to select a preset number from 1 to 40.

- 7 Press the [ENTER] button.

The station is copied to another channel and the preset number stops flashing.

Using the buttons on the CR-505DAB:

1. Select the preset that you want to copy.
2. Press the [MENU] button and turn the [◀/▶] control until “Preset Edit” appears on the display.
3. Push the [◀/▶] control.
4. Turn the [◀/▶] control until “Preset Copy?” appears on the display.
5. Push the [◀/▶] control.
6. While the preset number is flashing, use the [◀/▶] control to select a preset number from 1 to 40.
7. Push the [◀/▶] control.

RDS (Radio Data System)

The Radio Data System (RDS) allows FM radio stations to broadcast various information to RDS-compatible radios, including the name of the radio station and information about the program being broadcast. Many FM stations in most European countries transmit RDS information.

The CR-505DAB supports the following RDS information:

PS: Program Service Name

When tuned into a station that transmits PS information, the station’s name appears on the display.

RT: Radio Text

When tuned into a station that transmits RT information, any text messages received appear on the display.

When the CR-505DAB is tuned into a station that’s transmitting RDS information, the RDS indicator appears on the display.

To display the PS and RT information, press the [DISPLAY] button repeatedly to select Frequency display, PS, or RT, as shown.

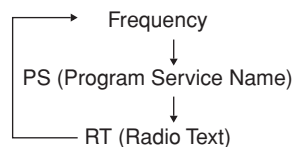

When the CR-505DAB receives RT information, “Please wait” appears on the display first, and then the received text scrolls across the display.

Other Functions

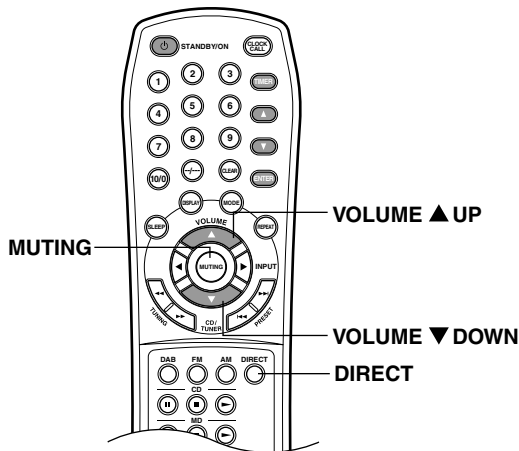
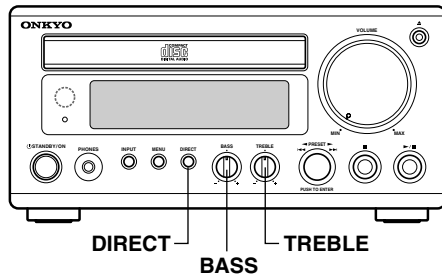

Muting the CR-505DAB

With this function you can temporarily mute the output of the CR-505DAB.

- 1 Press the remote controller's [MUTING] button.
The output is muted and "Muting" flashes on the display.
- 2 To unmute the CR-505DAB, press the [MUTING] button again, or adjust the remote controller's volume [▲]/[▼] buttons.

The output is unmuted and "Muting" goes off.

Note: The Mute function is cancelled when the CR-505DAB is set to Standby.

Adjusting the Bass & Treble

With the Bass and Treble functions you can adjust the tone of the sound to your personal preference.

- 1 Press the [DIRECT] button to select "Tone Direct Off."

Tone Direct Off

- 2 Use the [BASS] or [TREBLE] control on the CR-505DAB to adjust the bass or treble.

Using Direct Mode

In Direct mode, the bass and treble tone circuits are bypassed, creating a shorter signal path for a purer sound.

- 1 Press the [DIRECT] button to select "Tone Direct On."

Tone Direct On

- 2 To turn off Direct mode, press the [DIRECT] button again to select "Tone Direct Off."

Timers

About the Timers

The CR-505DAB has four timers so that you can turn it on and off automatically at certain times and on certain days of the week, in order to listen to, or record your favourite programs.

Timers can be used to start and stop playback (Play), or to start and stop radio or LINE input recording (Rec) with an Onkyo cassette tape deck or Mini Disc recorder connected via **RI**.

Timers can be set for single use (Once), in which case the timer is reset once the task has been completed, for use on a certain day every week (Every), or for a range of days (e.g., Monday through Friday).

■ Timer Examples

The following examples highlight some of the ways in which you can use the timers.

Timer 1: To wake up to your favourite radio station (preset #1) every morning, set as follows:

PLAY→FM 1→EVERY→EVERY DAY→ON 7:00→OFF 7:30

(If you want a radio alarm only on weekdays, select “Days Set” instead of “Every Day” and specify “MON–FRI.”)

Timer 2: To record a radio program (preset #2) on the cassette tape deck only this Sunday, set as follows:

REC→FM 2→TAPE→ONCE→SUN→ON 21:00→OFF 22:00
(You need an Onkyo cassette tape deck to do the recording.)

■ Timer Overlap

If two or more timers are set to the same ON time, the timer with the lowest number has priority. For example, if Timer #1 and Timer #2 are both set to an ON time of 7:00, Timer #1 has priority and Timer #2 is ignored.

Timer 1: 07:00 - 13:00 (This timer has priority.)

Timer 2: 07:00 - 12:30

If the settings of two timers overlap, the earlier timer has priority.

Timer 1: 9:00 - 10:00

Timer 2: 8:00 - 10:00 (This timer has priority.)

Notes:

- The timers work only if the CR-505DAB is in Standby mode. If the CR-505DAB is on when a timer is supposed to start playback or recording, nothing will happen, so be sure to switch the CR-505DAB to Standby mode.
- While a timed recording task is in progress, the output of the CR-505DAB is muted. To hear what’s being recorded, press the [MUTING] button to cancel the Mute function. Press it again to mute the CR-505DAB.

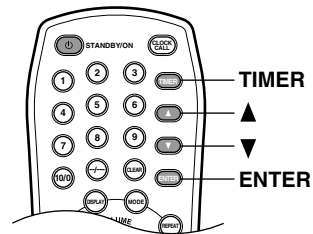

Setting the Timers

The timers are set using the remote controller.

You must set the clock (page 16) before you can set the timers.

To use a timer to turn on the radio, you must first preset some radio stations (see pages 26 and 29).

When the CD is selected for the input source, the timer cannot be set without a disc placed on the disc tray. This avoids forgetting to load a disc.

- 1 Press the [TIMER] button repeatedly to select Timer #1, #2, #3, or #4, and then press the [ENTER] button.

Timer1

- 2 Use the Up/Down [▲]/[▼] buttons to select “PLAY” or “REC,” and then press [ENTER].

PLAY

REC

- 3 Use the Up/Down [▲]/[▼] buttons to select the input source, and then press [ENTER].

For timed playback you can select any input source. For timed recording you can select DAB, AM, FM, or LINE.

If you select DAB, AM or FM, use the Up/Down [▲]/[▼] buttons to select a preset, and then press [ENTER].

When you select “REC” in step 2:

Use the Up/Down [▲]/[▼] buttons to select either “TAPE” or “MD” for the recording medium, and then press [ENTER].

4 Use the Up/Down [▲]/[▼] buttons to select “Once” or “Every,” and then press [ENTER].

Once: For single use.
Every: For weekly use.



5 Use the Up/Down [▲]/[▼] buttons to select one of the following options, and then press [ENTER].

- | | |
|-----------------|----------------|
| SUN (Sunday) | FRI (Friday) |
| MON (Monday) | SAT (Saturday) |
| TUE (Tuesday) | Every Day |
| WED (Wednesday) | Days Set |
| THU (Thursday) | |

The “Every Day” and “Days Set” (specifies a range of days) options only appear if you select “Every” in step 4.

If you select “Days Set,” use the Up/Down [▲]/[▼] buttons to select the first day, and then press [ENTER].

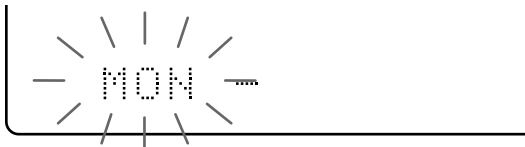

Use the Up/Down [▲]/[▼] buttons to select the last day, and then press [ENTER].

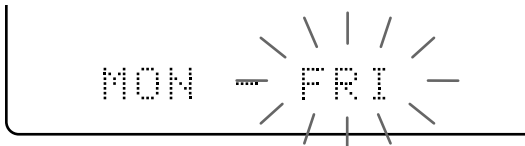

6 Use the [▲]/[▼] button to set the ON time, and then press [ENTER].



After the ON time has been set, the OFF time is automatically set to one hour later.

7 Use the [▲]/[▼] buttons to set the OFF time, and then press [ENTER].

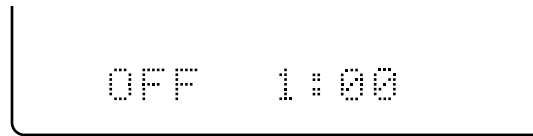

8 Use the Up/Down [▲]/[▼] buttons to select “Timer ON,” and then press [ENTER].

The TIMER indicator appears, as shown.

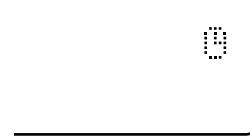

9 Press the [STANDBY/ON] button to set the CR-505DAB to Standby mode.

If you use any **RI**-connected cassette tape deck or MD recorder as a recording device, you must also set the device to standby mode.

Notes:

- You can cancel the timer setting procedure at any time by pressing the [TIMER] button.
- If you’re using a timer to start playback, be sure to set the volume to a suitable level. If the [VOLUME] control is set to minimum, you won’t hear anything when the timed playback task starts.
- If you set the playback source to CD, don’t forget to load a CD into the CR-505DAB before setting it to Standby mode.
- If you’re using a timer to start recording on an Onkyo cassette tape deck connected via **RI**, be sure to select the correct input source on the cassette tape deck, and load a cassette tape before switching the CR-505DAB to Standby mode.
- If you’re using a timer to start recording on an Onkyo Mini Disc recorder connected via **RI**, be sure to connect the recorder’s analog inputs to the CR-505DAB’s analog outputs. And be sure to select the correct input source on the MD recorder.
- For timed recording, it’s a good idea to set the start time a little before the actual start time of the program that you intend to record.

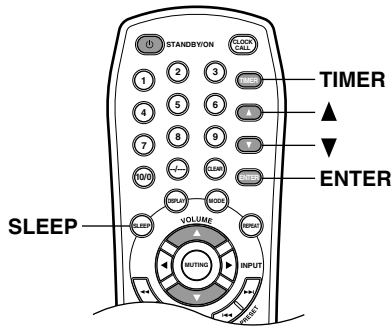

Turning Timers Off

You can turn timers on or off as necessary. This can be useful when, for example, you're on holiday and you don't want to be woken up by the timer that you normally use as an early-morning radio alarm.

- 1 Press the [TIMER] button repeatedly to select the timer that you want to turn off.
- 2 Use the Up/Down [▲]/[▼] buttons to select "Timer OFF."

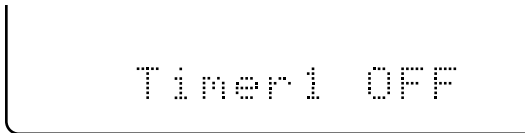

The timer is turned off, and the previous display reappears after two seconds. To turn a timer back on again, repeat this procedure and use the Up/Down [▲]/[▼] buttons to select "Timer ON."

Checking Timer Settings

You can check a timer's settings as follows.

- 1 Press the [TIMER] button repeatedly to select the timer that you want to check.
- 2 Press the [ENTER] button repeatedly to cycle through the timer's settings.

Note: You can edit the selected timer's settings as you check them. To do this, use the Up/Down [▲]/[▼] buttons to edit the currently displayed setting, and then press [ENTER] to move on to the next setting.

Using the Sleep Timer

With the sleep timer you can set the CR-505DAB so that it automatically turns off after a specified period.

- 1 Press the [SLEEP] button repeatedly to select the required sleep time.

With the [SLEEP] button you can set the sleep time from 90 to 10 minutes in 10 minute increments. The SLEEP indicator appears on the display when the sleep timer has been set, as shown. The specified sleep time appears on the display for about five seconds, then the previous display reappears.







To cancel the sleep timer, press the [SLEEP] button repeatedly until the SLEEP indicator disappears. To check the remaining sleep time, press the [SLEEP] button. Note that if you press the [SLEEP] button while the sleep time is being displayed, you'll shorten the sleep time by 10 minutes.

Disc Notes

Supported Discs

The CR-505DAB supports the following discs.

Disc	Logo	Format or file type
Audio CD		PCM
CD-R		Audio CD, MP3
		MP3
CD-RW		Audio CD, MP3
		MP3
CD Extra		Audio CD (Session 1), MP3 (Session 2)

- Some audio CDs use copy protection that doesn't conform to the official CD standard. Since these are non-standard discs, they may not play properly in the CR-505DAB.
- The CR-505DAB supports CD-R and CD-RW discs. However, some CD-R and CD-RW discs may not work properly for any of the following reasons: disc burner characteristics, disc characteristics, the disc is damaged or dirty. See the manual supplied with your disc burner for more information. Condensation or dirt on the optical pickup lens can also affect playback.
- The CR-505DAB supports 8 cm and 12 cm discs.
- Playback is not available for DTS CD.
- The CR-505DAB does not support disc types not listed.
- Don't use discs with an unusual shape, such as those shown below, because you may damage the CR-505DAB.



- Don't use discs that have residue from adhesive tape, rental discs with peeling labels, or discs with custom-made labels or stickers. Doing so may damage the CR-505DAB and you may not be able to remove the disc properly.

Discs Made on Personal Computers

Discs made on personal computers, including those of a compatible format, may not work properly in the CR-505DAB because of incorrect settings in the disc burning software. Check the manual supplied with your disc burning software for additional compatibility information.

MP3 Compatibility

- MP3 discs must be ISO 9660 Level 1 or Level 2, Romeo or Joliet compliant. Supported formats: Mode 1, Mode 2 XA Form 1.
- Folders can be up to eight levels deep.
- MP3 files must be MPEG-1/MPEG-2 Audio Layer 3 format with a sampling rate of between 16 kHz and 48 kHz and a bit-rate of between 32 kbps and 320 kbps (128 kbps or 192 kbps recommended). Incompatible files cannot be played.
- Fixed bit-rate MP3 files are recommended, however, variable bit-rate (VBR) MP3 files between 8 kbps and 320 kbps are supported (Playing times may display incorrectly).
- MP3 files must have a ".mp3" or ".MP3" file name extension. MP3 files without the proper extension will not be recognized. To prevent noise and malfunction, do not use these extensions for other types of files.
- The CR-505DAB supports up to 500 MP3 files and up to 200 folders per disc. (In this case, Disc and File names contain 30 characters and Folder names contain 20 characters.) Files and folders in excess of this cannot be played. Note that if the file and folder structure is very complicated, the CR-505DAB may not be able to read or play all of the MP3 files on the disc. If the disc, folder or file names contain many characters, the CR-505DAB may not support 500 MP3 files.
- Disc names may contain up to 30 characters. File and folder names may contain up to 60 characters.
- The maximum time that can be displayed for a single track is 99 minutes and 59 seconds.
- The remaining time cannot be displayed when playing MP3 files.
- Multisession discs are supported, however, some multisession discs may take a long time to load and some may not load at all. When burning CDs we recommend that you use a single session (disc-at-once), and select "Disc Close."
- The ID3 tag version 1.0 is supported.

Notes:

- With CD-ROM, CD-R, and CD-RW discs that contain many files and folders, and files other than MP3s, it may take a long time to read the disc. We recommend that you include only MP3 files on your discs, use about 20 folders, and limit folder nesting to three levels deep.
- **In this manual, MP3 files are referred to as tracks.**

Handling Discs

- Never touch the underside of a disc. Always hold discs by the edge, as shown.

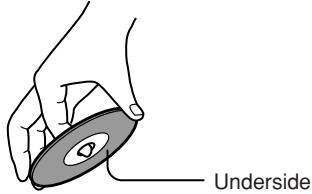

- Never attach adhesive tape or sticky labels to discs.



Cleaning Discs

- For best results, keep your discs clean. Fingerprints and dust can affect the sound quality and should be removed as follows. Using a clean soft cloth, wipe from the center outwards, as shown. Never wipe in a circular direction.



- To remove stubborn dust or dirt, wipe the disc with a damp soft cloth, and then dry it with a dry cloth.
- Never use solvent-based cleaning fluids, such as thinner or benzene, commercially available cleaners, or antistatic sprays intended for vinyl records, because they may damage the disc.

Storing Discs

- Don't store discs in places subject to direct sunlight, or near heat sources.
- Don't store discs in places subject to moisture or dust, such as in a bathroom or near a humidifier.
- Always store discs in their cases and vertically. Stacking, or putting objects on unprotected discs may cause warping, scratches, or other damage.

Troubleshooting

If you have any trouble using your CR-505DAB, check the following table for possible causes and remedies. If you still can't resolve the issue yourself, please contact your Onkyo dealer.

Trouble	Possible Cause	Remedy
Can't turn on the CR-505DAB?	The power cord is not connected properly.	Connect the power cord properly to a suitable wall outlet (page 16).
There's no sound coming from the speakers?	The speaker cables are not connected properly.	Check the speaker connections and make sure that none of the wires are touching each other, other connectors, or any metal parts (page 11).
	The volume is set at minimum.	Turn up the volume (page 19).
	The CR-505DAB is muted.	Unmute the CR-505DAB (page 31).
	A pair of headphones is connected.	Turn down the volume, then disconnect the headphones (page 19).
	The wrong input source is selected.	Check the input source setting (page 19).
	A connecting cable may be damaged.	Check your connecting cables for signs of damage and replace as necessary.
Sound is coming from only one speaker?	The other speaker's cable is not connected properly.	Check the speaker connections and make sure that none of the wires are touching each other, other connectors, or any metal parts (page 11).
The remote controller doesn't work?	The batteries are used.	Replace with new batteries (page 7).
	The batteries are installed incorrectly.	Check the batteries and correct as necessary (page 7).
	You're not pointing the remote controller at the CR-505DAB's remote sensor.	Point the remote controller at the CR-505DAB's remote sensor (page 7).
	A strong light source is interfering with the CR-505DAB's remote sensor.	Make sure that the CR-505DAB is not subjected to direct sunshine or inverter-type fluorescent lights. Relocate if necessary.
AM reception is hindered by a buzzing noise, especially at night or with weak signals?	Interference caused by electrical equipment, including fluorescent lights.	Relocate your AM antenna.
		Install an outdoor AM antenna (page 13).
AM reception is hindered by a high-pitched noise?	Interference caused by your TV.	Move the AM loop antenna as far away as possible from your TV.
		Move the CR-505DAB as far away as possible from your TV.
Reception is hindered by a crackling noise?	Interference is being caused by fluorescent lights being turned on or off, or by the ignition systems of passing cars.	Install an outdoor antenna as far away as possible from nearby roads.
		Move your antenna as far away as possible from fluorescent lights.
		Adjust the position or direction of your outdoor antenna.
FM reception and stereo separation are poor even though the Tuning and "ST" (FM stereo) indicators are shown.	Tall buildings, mountains, or hills are causing wave reflections that interfere with the main signal.	Try an FM antenna with better directionality.
	The station's signal is too strong.	Try an indoor FM antenna.

Troubleshooting—Continued

Trouble	Possible Cause	Remedy
Reception is noisy, intermittent, and the “ST” (FM stereo) indicator flickers?	You’re too far away from the transmitter. Or, your FM antenna is in the wrong position or pointing in the wrong direction. Or, the station’s signal strength is poor.	Switch the FM Mode to Mono (page 28).
		Adjust the position, height, and direction of your FM antenna.
		Install an outdoor FM antenna, preferably one with many elements. Installing an outdoor antenna is a specialist’s job, so contact your nearest dealer for advice (page 13).
The radio presets no longer work?	The power cord has not been connected to a wall outlet, or the power has been turned off for an extended period.	Preset your favourite radio stations again (pages 26 and 29). The power cord must be plugged into a wall outlet a few times each month in order to preserve the presets (page 4).
The RDS (Radio Data System) doesn’t seem to work?	The current FM station does not support RDS.	Tune into a station that supports RDS (page 30).
	The signal strength is poor, or there’s too much interference.	Install an outdoor FM antenna (page 13), change the position or direction of your outdoor FM antenna, and keep it away from fluorescent lights.
CD playback skips?	The CR-505DAB is subject to vibration.	Install the CR-505DAB somewhere free of vibration.
	The disc is dirty.	Remove the disc and clean it (page 36).
	The disc is very scratched.	Buy a new disc.
Noise is generated.	DTS CD is being replayed.	Do not replay DTS CD, which is not supported by the CR-505DAB.
Can’t play a CD?	The disc is upside down.	Load the disc with the label-side facing up (page 20).
	The disc is dirty.	Remove the disc and clean it (page 36).
	Condensation has formed inside the CR-505DAB.	Remove the disc and leave the CR-505DAB turned on for several hours until the condensation has evaporated.
	The CD-R/RW disc is nonstandard.	See “Disc Notes” (page 35).
It takes a long time to read CD/MP3.	It may take a longer time to read CD/MP3 with many track numbers.	This is not a malfunction.
It takes a long time to locate certain tracks.	The disc is dirty.	Remove the disc and clean it (page 36).
	The disc is very scratched.	Buy a new disc.
Does not operate during the ACCUCLOCK function with a message “Clock Setting” displayed.	Bad receiving conditions may interfere with the setting of the clock using ACCUCLOCK function.	Press the [DISPLAY] button to disengage ACCUCLOCK, and then set the clock manually.
The clock is wrong?	CT (Clock Time) information has been taken from a radio station in another time zone.	Set ACCUCLOCK to use a specific station (page 17).
The CR-505DAB turns itself on unexpectedly?	The ACCUCLOCK function is calibrating the clock.	This is not a malfunction. The CR-505DAB will turn itself off automatically when the ACCUCLOCK function has calibrated the clock.

Troubleshooting—Continued

Trouble	Possible Cause	Remedy
The timer didn't work?	The CR-505DAB was already on at the specified ON time.	Set the CR-505DAB to Standby (page 33). The CR-505DAB must be in Standby mode, otherwise the timed task will not work.
	The RI -connected cassette tape deck or MD recorder had not been in standby mode.	You must set the recording devices to standby mode too.
	The specified ON time coincided, or overlapped the ON time of another timer.	Check the timer settings and correct as necessary (page 34).
	The CR-505DAB is only connected digitally to the MD recorder.	To make recordings with RI -connected MD recorder, connect the recorder's analog inputs to the CR-505DAB's analog outputs.
No sound is output when a timed playback or recording task starts?	While a timed recording task is in progress, the output of the CR-505DAB is muted.	To hear what's being recorded, press the [MUTING] button to cancel the Mute function. Press it again to mute the CR-505DAB.
	For timed playback, the volume is determined by the [VOLUME] control.	Set the volume to a suitable level (page 19).
RI doesn't work.	There's no RCA/phono analog audio connection.	To use RI you must make an analog audio connection (RCA/phono) between CR-505DAB and your Onkyo components even if they are connected digitally.
Standby indicator flashes.	The protection circuit may be activated.	Make sure not to short-circuit the positive and negative speaker wires.

Abnormal Behavior

The CR-505DAB contains a microcomputer for signal processing and control functions. In very rare situations, severe interference, noise from an external source, or static electricity may cause it to lockup. In the unlikely event that this should happen, unplug the power cord from the wall outlet, wait at least five seconds, and then plug it back in again.

Restoring the Default Settings

To reset the CR-505DAB to its factory defaults, turn it off and unplug the power cord. Then press and hold the [STANDBY/ON] button on the CR-505DAB, and plug in the power cord.

Specifications

AMP

Power Output: 20 W + 20 W (4 Ω, 1 kHz, DIN)
25 W + 25 W (4 Ω, 1 kHz, JEITA)
Dynamic power: 30 W + 30 W (4 Ω, Front)
THD (Total Harmonic Distortion):
0.2% (5 W Output 4 Ω)
Damping Factor: 25 (Front, 1 kHz, 8 Ω)
Input Sensitivity and Impedance:
200 mV/50 kΩ (LINE)
Output Level and Impedance:
200 mV/2.2 kΩ (REC OUT)
Frequency Response: 10 Hz-50 kHz/+3 dB, -3 dB (line)
Tone Control: +9 dB, -8.2 dB, 100 Hz (BASS)
+11 dB, -9 dB, 10kHz (TREBLE)
S/N Ratio 97 dB (LINE, IHF-A)
Speaker Impedance: 4 Ω-16 Ω

FM

Tuning Frequency Range:
87.5-108 MHz
Usable Sensitivity:
Stereo 37.2 dBf 20.0 μV (75 Ω IHF)
Mono 17.2 dBf 2.0 μV (75 Ω)
S/N Ratio:
Stereo 55 dB (IHF-A)
Mono 66 dB (IHF-A)
THD (Total Harmonic Distortion):
Stereo 0.46% (1 kHz)
Mono 0.4% (1 kHz)
Frequency Response: 30 Hz-15 kHz/+1.5 dB, -1.5 dB
Stereo Separation 37 dB (1 kHz)

AM

Tuning Frequency Range:
522-1611 kHz
Usable Sensitivity: 55 dB (30 μV)
S/N Ratio: 35 dB
THD (Total Harmonic Distortion):
1.60%

DAB

Tuning Frequency Range:
174.928-239.200 MHz
Frequency Response: 20 Hz-20 kHz
Audio Dynamic Range:
63 dB
THD (Total Harmonic Distortion):
0.20%

CD

Signal Readout: Optical non-contact
Frequency Response: 20 Hz-20 kHz
Audio Dynamic Range:
96 dB
THD (Total Harmonic Distortion):
0.01%
Wow and Flutter: Below threshold of measurability
Audio Output (Digital/Optical):
-22.5 dBm
Audio Output/Impedance (Analog):
1.3 V (rms) /2.2 kΩ

General

Power Supply: AC 230-240 V, 50 Hz
Power Consumption: 75 W
Stand-by Power Consumption:
1.0 W
Dimensions (W x H x D):
205 W x 103 H x 356 D mm
Weight: 5.3 kg

Specifications and features are subject to change without notice.

ONKYO CORPORATION

Sales & Product Planning Div.: 2-1, Nisshin-cho, Neyagawa-shi, OSAKA 572-8540, JAPAN
Tel: 072-831-8023 Fax: 072-831-8124

ONKYO U.S.A. CORPORATION

18 Park Way, Upper Saddle River, N.J. 07458, U.S.A.
Tel: 201-785-2600 Fax: 201-785-2650 <http://www.onkyousa.com>

ONKYO EUROPE ELECTRONICS GmbH

Liegnitzerstrasse 6, 82194 Groebenzell, GERMANY
Tel: +49-8142-4401-0 Fax: +49-8142-4401-555 <http://www.onkyo.net>

ONKYO EUROPE UK Office

Suite 1, Gregories Court, Gregories Road, Beaconsfield, Buckinghamshire, HP9 1HQ
UNITED KINGDOM Tel: +44-(0)1494-681515 Fax: +44(0)-1494-680452

ONKYO CHINA LIMITED

Units 2102-2107, Metroplaza Tower I, 223 Hing Fong Road, Kwai Chung,
N.T., HONG KONG Tel: 852-2429-3118 Fax: 852-2428-9039



D0408-2

SN 29343871A

(C) Copyright 2004 ONKYO CORPORATION Japan. All rights reserved.



* 2 9 3 4 3 8 7 1 A *